

KENWOOD

HF TRANSCEIVER

TS-940S



TS-940S

HF TRANSCEIVER

The TS-940S is a competition class HF transceiver having every conceivable feature, and is designed for SSB, CW, AM, FM and FSK modes of operation on all 160 through 10 meter Amateur bands, including the new WARC bands. It incorporates an outstanding 150 kHz to 30 MHz general coverage receiver having a superior dynamic range (102 dB typical on 20 meters, 50 kHz spacing, 500 Hz CW bandwidth).

Engineered with the serious DX'er/contest operator in mind, the TS-940S features a wide range of innovative interference rejection circuits, including SSB IF slope tuning, CW VBT (Variable bandwidth tuning), IF notch filter, AF tune circuit, Narrow/Wide filter selection, CW variable pitch control, dual-mode noise blanker, and RIT plus XIT. The use of a new microprocessor with advanced digital technology controlled operating features, plus two VFO's, 40 memory channels, programmable memory and band scans, a large fluorescent tube digital display with analog-type sub-scale for frequency indication, and a new dot-matrix LCD sub-display for showing graphic characteristics and messages, all serve to provide maximum flexibility and ease of operation. In addition, a CW full break-in circuit, switchable to semi break-in, a built-in automatic antenna tuner, a solid-state final amplifier that is powered from a higher voltage source, a speech processor, all-mode squelch, and a host of other convenience features all add up to even greater versatility of use in fast-paced DX operations. With its power supply and antenna tuner built-in, and with its new whisper-quiet cooling system, the TS-940S is a complete, all-in-one type transceiver that brings tomorrow's sophistication to today's serious enthusiast. The unit may be ordered with the antenna tuner installed or available as an option.

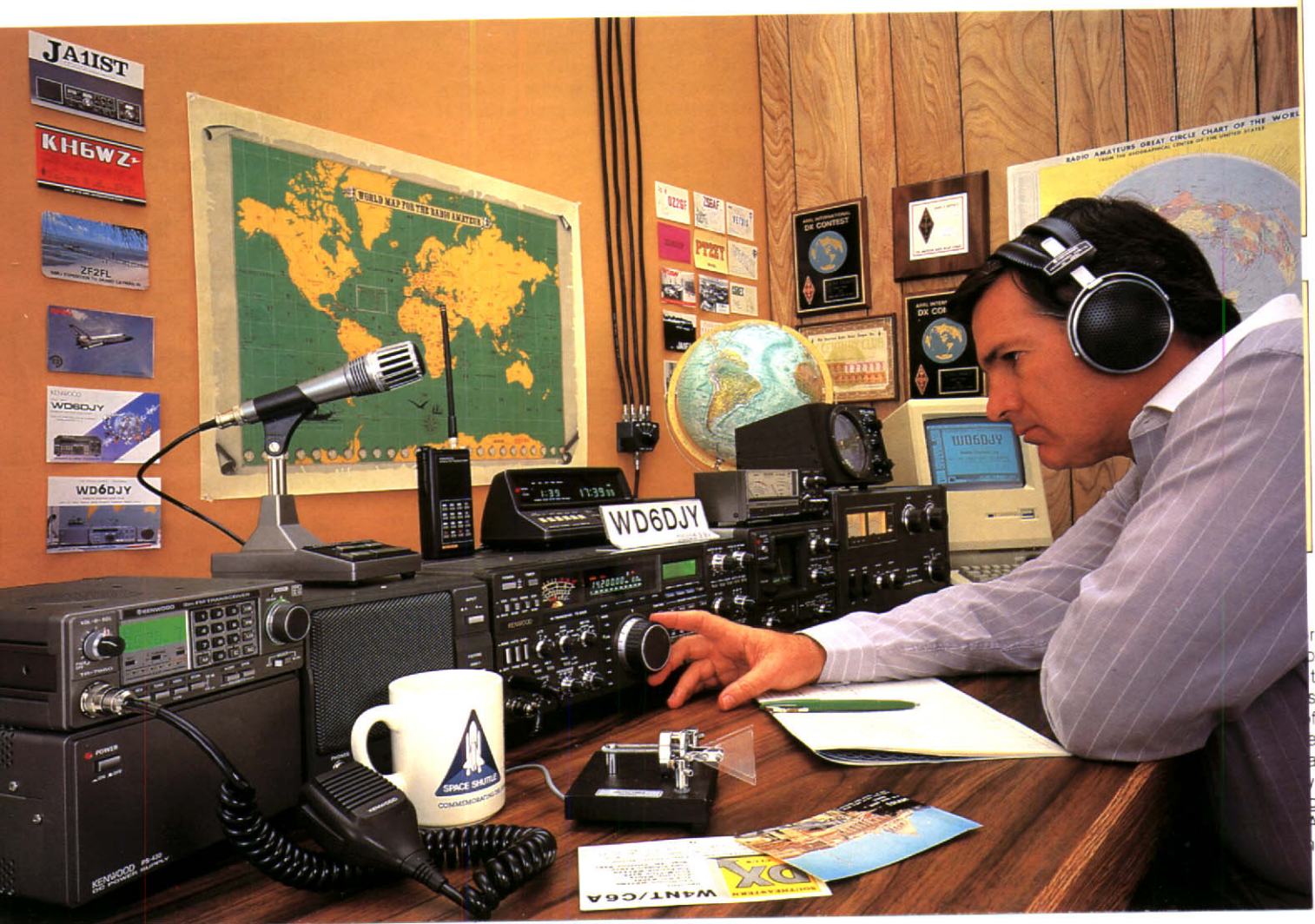

at FULL, or semi break-in at SEMI.

Messages/Clock

SET • Used to set the "2" mark on the time display for setting time adjustment.
• Used when erasing time-controlled set time.

MONI (MONITOR)

ATT (RF attenuator)
(0, -10, -20, -30 dB)

DIM

PROC (processor) switch

MAIN DISPLAY
Frequency/VFO A, B
MCH (Memory Channel)/RIT, XIT

MEMORY function
Used to select memory scan, program scan VFO or memory operation.

BAND/KEY
• Selects Amateur bands
Ten keys: Used when setting the frequency.

NOTCH → **SQL controls**

PITCH → **AF TUNE controls**

AF → **RF controls**

RIT/XIT control
Shifts the receive/transmit frequency in 10 Hz steps within a range of ±9.99 kHz when the RIT/XIT mode has been selected.



STAND-BY

NB 1/NB 2 switches

NAR/WIDE
Selects the narrow or wide IF bandwidth.

AUTO/THRU
AUTO: Antenna tuner is ON.
THRU: Antenna tuner is OFF.

NB LEVEL control
Controls noise blanker operating level.

MODE switches
The first letter of the mode (FSK mode: "R.") is announced in International Morse Code.

MIC (microphone gain) → PWR (RF power) controls
• Controls microphone amplifier gain for SSB operation.
• Controls the transmit power in SSB, CW and FM modes.

PROCESSOR-IN → PROCESSOR-OUT controls
Controls compression level, speech processor output level.

AT T switch
Used when operating the transceiver in conjunction with the built-in antenna tuner.

CW VBT control
Continuously adjusts the IF filter bandwidth to eliminate radio interference.

SSB SLOPE TUNE control
This permits independent variation of the high and low frequency slopes of the IF passband. High and low audio frequencies may be simultaneously cut (tuned).

UP/DOWN
Shifts 1 MHz up/down.

FUNCTION switches

• **T-FSET switch**
Depress this switch to "SPOT", or momentarily interchange reception frequency with transmission frequency. Frequency "SPOTTING" is possible only in receive and is ineffective during transmission.

• **A/B** — Selects the VFO A or VFO B.
• **SPLIT** — For split frequency operations A-R, B-T or B-R, A-T.
• **A=B** — During VFO operation, press this switch to equalize the frequency and mode of the idle VFO to that of the active VFO.

• **F. LOCK** — Press this switch to lock the VFO and BAND switches.
• **VOICE** — Announces the frequency when an optional VS-1 is installed inside the cabinet.

PHONE PATCH jacks

RTTY KEY jack
For FSK operation

Cooling fan (final section)
Electronically controlled automatic cooling fan for the final amplifier section.

EXT. SP (speaker) jack
For use of an external 4 to 6 Ω speaker

Cooling fan (power supply)
Electronically controlled automatic cooling fan for the power supply section.

ANTENNA CONNECTOR
(50 Ω)

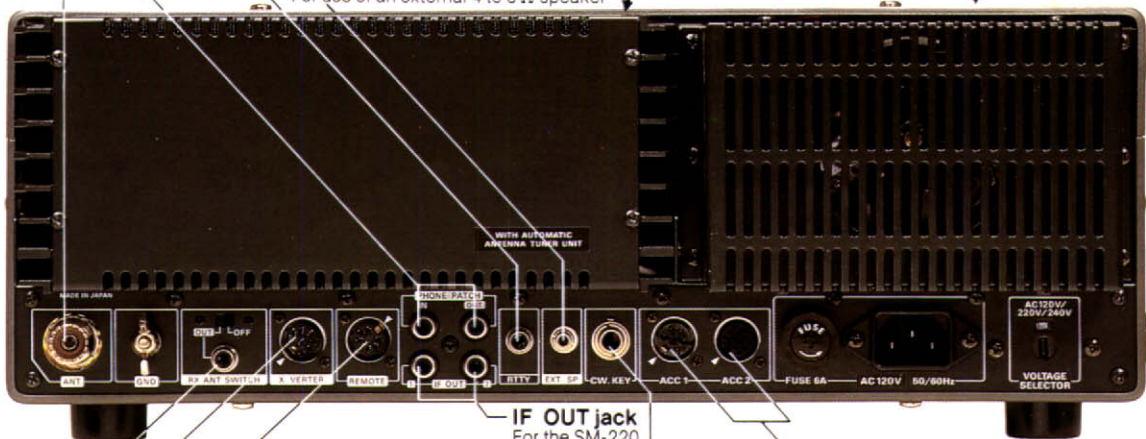

RX ANTENNA JACK/SWITCH
Auxiliary receiver connector

REMOTE CONNECTOR
Linear amplifier or other accessory item.

XVERTER (transverter)
Used to interface a VHF or UHF transverter.

IF OUT jack
For the SM-220 station monitor.

CW KEY jack
Using shielded line, connect a key to this 1/4" phone jack for CW operation.

ACC1 For a computer interface.

ACC 2 For connecting data communications

Highly Efficient, Ducted Air-Flow, Cooling System

A new air distribution system allows operation on a 100% transmit duty cycle basis for periods of approximately one hour.

The heat sink cooling fins are designed to be an integral part of the ducted air-flow system, which is constructed in such a manner as to assure a continual flow of air across the front and rear surfaces of the heat sink, as well as over the fins themselves. Ports of varying sizes have been strategically located throughout the air-flow system to prevent dead-air pockets. Cooling air is drawn through the cabinet area by a whisper-quiet, two-speed fan that then directs its discharge air-flow into the ducting at a point immediately adjacent to the final amplifier transistors, assuring maximum heat transfer from these important components. Fan operation is controlled through use of automatic switching initiated by a detecting thermistor that senses final amplifier temperature.

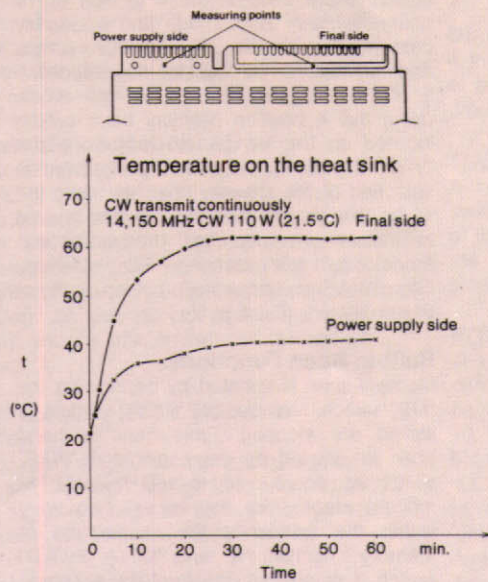

Laminated Core Transformer

The power transformer is high performance, shielded, and potted to protect the windings and connections from vibration and impact damage.

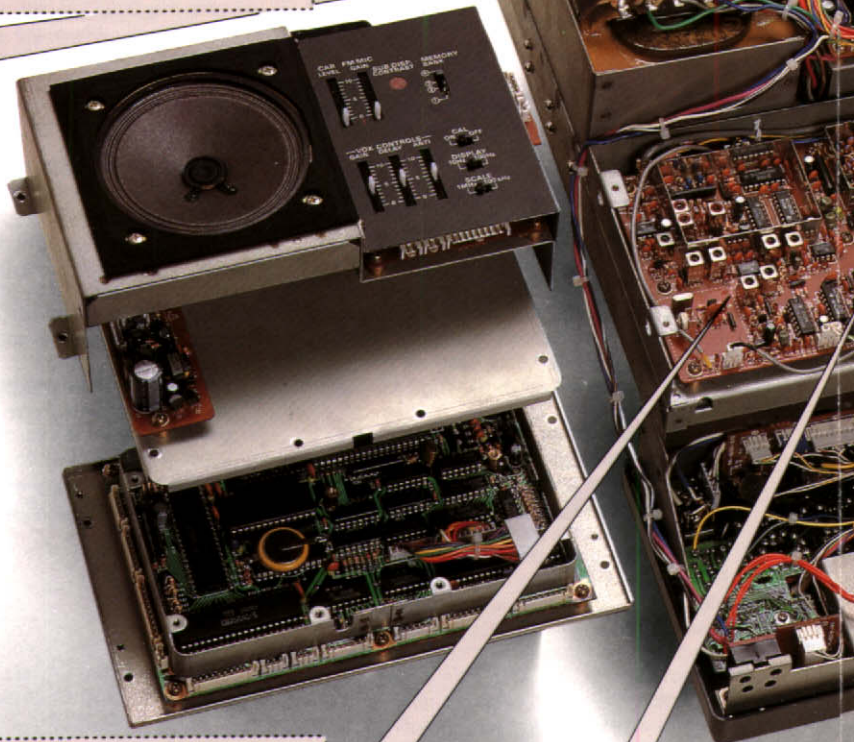
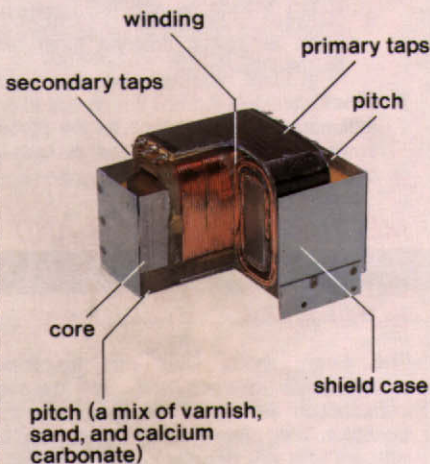

RF unit

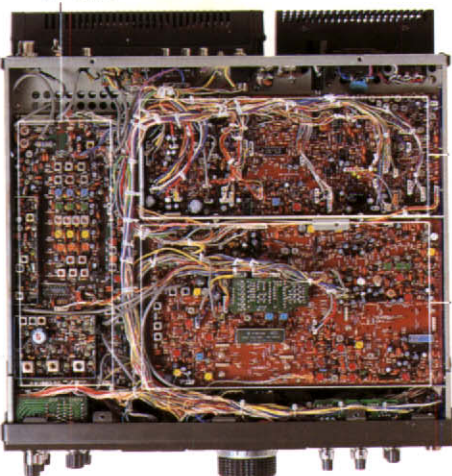

Optional SO-1 TCXO Temperature Compensated Crystal Oscillator.

An optional, high-stability TCXO, model SO-1, may be installed in place of the reference oscillator. This unit operates at 20-MHz with an accuracy of $\pm 5 \times 10^{-7}$ to the 7th negative power across a temperature range of -10 degrees C to $+50$ degrees C when installed inside the TS-940S. With the SO-1 installed, overall frequency stability is upgraded to a level approximating professional standards.

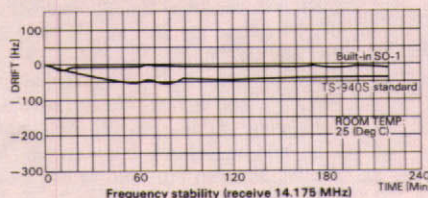

Phase Locked Loop (PLL) Circuit

This is a digital Variable Frequency Oscillator (VFO) covering 45.2–75.05 MHz in 10 Hz steps, in accordance with the TS-940S operating frequency of 150 kHz to 30 MHz. Three PLLs are linked in analog mode. The dividing ratio data to each PLL is controlled by the microprocessor. Each PLL has a single-crystal frequency standard. The reference frequency is accurate to ± 10 ppm between -10°C and $+50^\circ\text{C}$.

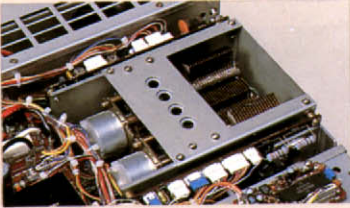

Automatic Antenna Tuner

Forward and reflected waves are detected by a directional coupler. Signals proportional to the antenna line voltage and current are processed for phase comparison. These signals are used to control servo motors which turn the two antenna tuner capacitors for minimum SWR. (The two variable capacitors are controlled independently.) During the tuning cycle, an LCD sub-display indicates "ANTENNA TUNER TUNING." When SWR is minimized (1.2:1 or less), the motors stop and the tuning display indicates "TUNING FINISHED—TX READY."

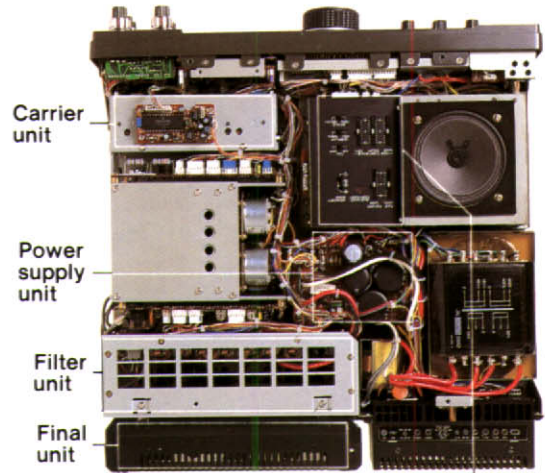

- Carrier unit
- Power supply unit
- Filter unit
- Final unit

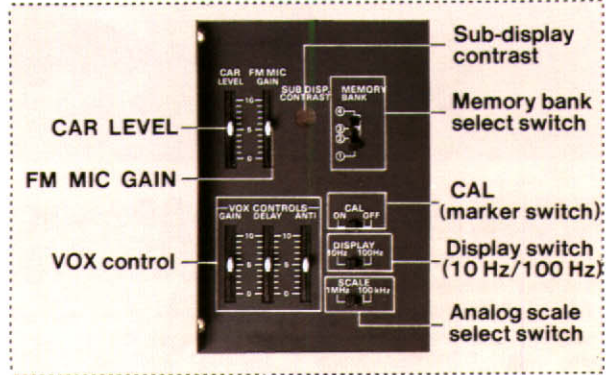
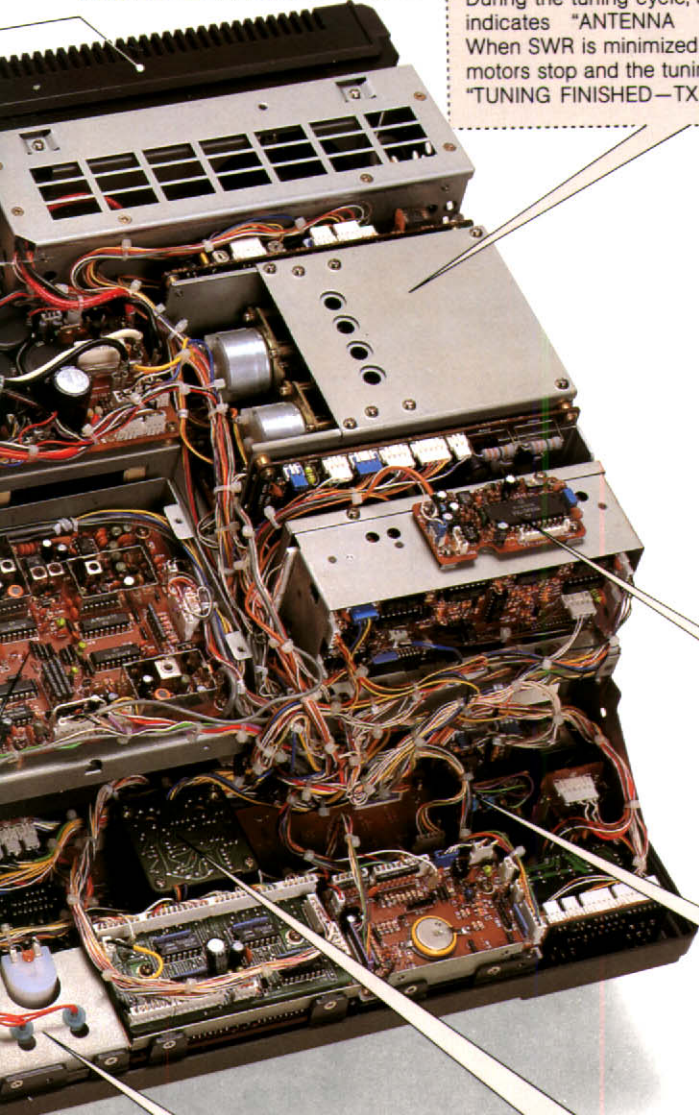

- CAR LEVEL
- FM MIC GAIN
- VOX control
- Sub-display contrast
- Memory bank select switch
- CAL (marker switch)
- Display switch (10 Hz/100 Hz)
- Analog scale select switch

Voice Synthesizer Unit (option)

The optional VS-1 voice synthesizer is easily installed inside the cabinet, and announces the main display frequency on demand.

Variable Speed Tuning With Solid State Optical Encoder

Special tuning logic, working with the 10 Hz step high stability digital VFO, provides frequency changes directly related to the speed of tuning knob rotation. The special KENWOOD-engineered Optical Encoder Tuning System provides smooth, backlash-free tuning. Rotating the VFO knob at normal tuning speeds shifts the frequency in 10 Hz increments, or 10 kHz per VFO knob revolution. Tuning the knob faster (approximately 2 to 3 revolutions per second), increases frequency step size proportionally.

RIT/XIT Encoder Mechanics.

The RIT/XIT control employs a molded optical encoder disk having fifty slits located along its outer circumference, providing a total of 2 kHz frequency shift in 10 Hz steps, for each 360 degrees of knob rotation.

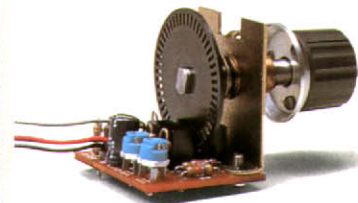

Easy-To-Read, Illuminated Multi-Function Meter.

The front panel multi-function meter utilizes a black background color selected to harmonize with the main display. Backlighted calibration numerals, and a pointer tip coated with an orange fluorescent material, provide for superior readability and easy detection of minor variations in the reading.

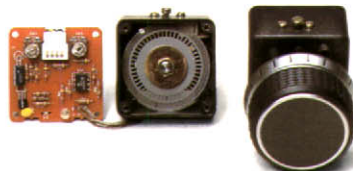
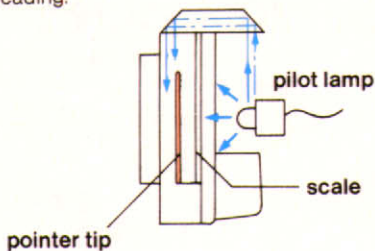

OPTIONAL ACCESSORIES



MC-60A



SP-940



TS-940S

MC-60A (50 k Ω /500 Ω)

Deluxe Desk-Top Microphone with built-in Pre-amplifier (8 pin)
The zinc die-cast base provides high stability, and the MC-60A is complete with PTT and LOCK switches, UP/DOWN switches, an impedance selector switch and a built-in pre-amplifier.

MC-42S (500 Ω)

UP/DOWN Hand Microphone (8 pin)

The MC-42S is handy dynamic microphone with PTT switch and UP/DOWN switches.



PC-1A

Phone Patch Controller (Available only where phone patch operation is legal)

Model PC-1A phone patch has been carefully engineered and manufactured under rigid quality standards, and should give satisfactory and dependable operation for many years.



YK-88A-1

6 kHz AM Filter for 8.83 MHz IF

- Center Frequency: 8830.0 kHz
- Selectivity: 6 kHz (-6 dB), 11 kHz (-60 dB)
- Guaranteed Attenuation: More than 80 dB



MC-80 (700 Ω)

Desk-Top Microphone with built-in Pre-amplifier (8 pin)

The MC-80 is an omnidirectional electret condenser microphone provided with UP/DOWN switch, volume adjustment for output level, PTT and LOCK switch, and built-in pre-amplifier.



MC-85 (700 Ω)

Multi-function Desk-Top Microphone with built-in Audio Level Compensation (8 pin)

The MC-85 is an unidirectional high-class electret condenser microphone provided with the output selective switch, audio level compensation circuit, low cut filter, level meter, PTT and LOCK switch.



VS-1

Voice Synthesizer unit



YK-88C-1

500 Hz CW Filter for 8.83 MHz IF

- Center Frequency: 8830.0 kHz
- Selectivity: 500 Hz (-6 dB), 1.5 kHz (-60 dB)
- Guaranteed Attenuation: More than 80 dB



SP-940

External Speaker

The SP-940 is a high class external speaker designed to match the TS-940S in size, color and appearance. The SP-940 uses a panel made of reinforced ABS plastic and an expanded metal speaker grill to improve tone quality. It is a low-distortion speaker with selectable frequency response for high intelligibility in any mode. The frequency response is determined by the built-in audio filters, which are effective in improving signal-to-noise-ratio under certain interference conditions, or when receiving weak signals. On the front panel is a headphone connector, for listening to audio output passed through the filters. Also on the front panel is a switch for selecting either of two audio inputs to the SP-940.

Specifications

- Speaker Diameter: 100 mm (4 inch)
- Input Power (max.): 1.5 W (3.0 W)
- Impedance: 8 Ω
- Frequency Response: 100 Hz ~ 5 kHz
- Filter Cut-off Frequency: LOW 430 Hz (-3 dB)/HIGH1 1 kHz (-3 dB)/HIGH2 2.5 kHz (-3 dB)/HIGH1 + HIGH2 730 Hz (-3 dB)
- Filter Attenuation: -6 dB/OCT
- Dimensions: 180 (7.01) W \times 140 (5.51) H \times 290 (11.4) D mm (inch), (Projections not included)
- Weight: 2 kg (4.41 lbs) approx.

YG-455C-1

500 Hz CW Filter for 455 kHz IF

- Center Frequency: 455.0 kHz
- Selectivity: 500 Hz (-6 dB), 820 Hz (-60 dB)
- Guaranteed Attenuation: More than 80 dB



HS-4

Headphones (8 Ω)



HS-5

Deluxe Headphones (8 Ω)



HS-6

Small-sized Headphones (12.5 Ω)



HS-7

Micro Headphones (16 Ω)



SO-1

Superior Stability TCXO (Temperature compensated crystal oscillator)

- (Requires modifications)
- Frequency Oscillator: 20 MHz
- Frequency Stability: $\pm 5 \times 10^{-7}$ (temperatures)
- Frequency Correct Range: Better than ± 60 Hz



YG-455CN-1

250 Hz CW Narrow Filter for 455 kHz IF

- Center Frequency: 455.0 kHz
- Selectivity: 250 Hz (-6 dB), 480 Hz (-60 dB)
- Guaranteed Attenuation: More than 80 dB



SW-2000



SM-220

TL-922/TL-922A (for U.S.A.)



SM-220

Station Monitor

Based on a wide-frequency-range oscilloscope (up to 10 MHz), the SM-220 station monitor features, in combination with a built-in two-tone generator, a wide variety of waveform-observing capabilities. When the BS-8 is installed in the SM-220 and connected to the transmitter, signal conditions in the vicinity of the receive frequency can be viewed over a ± 20 kHz or ± 100 kHz range. The SM-220 provides efficient station operation as it monitors transmitted waveforms, and it also serves as a high-sensitivity, wide-frequency range oscilloscope for various adjustments and experiments.

SPECIFICATIONS

(Transmit Signal Monitor Terminal)

- Frequency range: 1.8~150 MHz
- Maximum power: 1 kW (1.8~54 MHz), 50 W (150 MHz)
- SWR: 1.2:1 or less
- Deflection sensitivity: Better than 1 div. at 2 W input
- Attenuator: 6 steps (Trapezoid waveform observation)
- Frequency range: 1.8~30 MHz
- Maximum power at DRIVE TERMINAL: 2~100 W
- SWR: 1.2:1 or less (Two-tone generator)
- Oscillator frequency: 1,000 Hz and 1,575 Hz
- Output voltage: 10 mV/50 k Ω (at TWO TONE) (Pan display unit)
- Input center frequency: 8.830 MHz
- IF frequency: 455 kHz
- IF bandwidth: More than 1 kHz (-6 dB)
- Input sensitivity: Better than 10 μ V/div.
- Scan width: ± 20 kHz, ± 100 kHz, switchable gain (Horizontal amplifier)
- Deflection sensitivity: More than 300 mV/div.
- Frequency response: DC-250 kHz or over (EXT GAIN at MAX); DC-40 kHz (EXT GAIN at 1/2)
- Input resistance/capacitance: 1 M Ω ($\pm 20\%$)/35 PF or less (SYNC switch at INT)
- Attenuator: Fully variable to 0
- Max. input voltage: 100 Vp-p

SW-200A, 2000

SWR/POWER Meter (supplied with a coupler)

SW-200A supplied with SWC-1
SW-2000 supplied with SWC-3
Selectable Peak-reading/RMS, SWR/POWER meters for base station use.

SPECIFICATIONS

- Impedance: 50~52 Ω
- Frequency range: 1.8~150 MHz (SW-200A) 1.8~54 MHz (SW-2000)
- Power measuring range: 0~20/200 (SW-200A) 0~200/2000 W (SW-2000)
- Accuracy: Less than $\pm 10\%$ of full scale
- Sensitivity: Less than 20 W
- Power supply: 12 VDC 100 mA
- Dimensions: 193 (7.6) W \times 62 (2.4) H \times 79 (3.1) D mm (inch)
- Weight: 0.7 kg (1.5 lbs.) approx.

(Sweep circuit)

- Sweep frequency: 10 Hz~100 kHz (4 ranges, with fine adjustment)
- Sweep linearity: Better than 5%
- Sync system: Synchronized sweep, internal negative sync and external sync
- Sync amplitude: Internal; Better than 1 div. on CRT, External; Better than 2 Vp-p (Vertical amplifier)
- Deflection sensitivity: Better than 20 mV/div.
- Frequency response: 2 Hz~10 MHz (-3 dB)
- Input resistance/capacitance: 1 M Ω /40 PF
- Overshoot: Less than 5%
- Attenuator: 1, 1/10, 1/100 and GND/MONITOR (Error between steps: 5% max.)
- Max. input voltage: 300 V (DC+AC peak) or 600 Vp-p
- Power supply: 120/220/240 V AC $\pm 10\%$, 50/60 Hz 20 W
- Dimensions: 215 (8.6) W \times 153 (6.1) H \times 335 (13.4) D mm (inch)
- Weight: 5 kg (11 lbs.)

OPTIONAL ACCESSORIES

- BS-8.... Pan Display for TS-830S/TS-530S/TS-180S/TS-820 series/TS-940S
- BS-5.... Pan Display for TS-520/TS-520SE

TL-922/TL-922A

HF Linear Amplifier (for U.S.A.)

The TL-922/TL-922A are class AB₂ grounded-grid linear amplifiers developed by KENWOOD through advanced high-power technology using two high-performance EIMAC 3-500Z power tubes. They cover all bands 160 m through 10 m* (except the three new Amateur bands) for SSB, CW and RTTY modes of operation. (not usable with full break-in, semi break-in only)

FEATURES

- Pair of EIMAC 3-500Z high performance transmitting tubes
- Class AB₂ G-G circuit
- Excellent IMD (intermodulation products distortion) characteristics
- Perfect safety protection
- Blower turn-off DELAY circuit
- Variable threshold level type ALC circuit
- Two easy-to-read meters
- Attractive matching with KENWOOD HF transceivers.

SPECIFICATIONS

- Frequency range: 1.8~2.0 MHz, 3.5~4.0 MHz, 7.0~7.3 MHz, 14.0~14.35 MHz, 21.0~21.45 MHz, 28.0~29.7 MHz (not on TL-922A)
- Mode: SSB CW, RTTY
- Drive power: 80 W or more for full output
- RF input power: SSB=2,000 W PEP, CW, RTTY=1,000 W DC
- Circuitry: AB₂ class grounded-grid linear amplifier
- Input impedance: 50 Ω
- Output impedance: 50~75 Ω
- Cooling: Forced air
- Fan motor delay stop time: 140 \pm 30 seconds
- ALC: Negative going adjustable threshold -8 V DC max. output (typical)
- Tubes: 2 \times 3-500Z (optional)
- Power requirement: 120/220 V 28 A, 50/60 Hz type, 220/240 V 14 A, 50/60 Hz type
- Dimensions: 390 (15.4) W \times 190 (7.5) H \times 407 (16.0) D mm (inch)
- Weight: 31 kg (68 lbs.)

* The model TL-922A with tubes is available only in U.S.A. and does not cover 10 meter band.

AT-940

Automatic Antenna Tuner

The AT-940 is an optional automatic antenna tuner that can be installed in the TS-940S.

FEATURES

- Full coverage of 160 through 10 meters, including the new WARC bands.
- Automatic motor speed control. The motor automatically stops when the SWR drops to its minimum value (1.2:1 or less).
- The AUTO-THRU circuit is disabled during transmission to protect the final transistors in case the AUTO-THRU switch is accidentally operated.
- The "tune" condition for automatic antenna tuning remains unchanged during transmission when the "AT.T" switch is depressed.

SPECIFICATIONS

- Frequency Range: All Amateur bands from 1.8 to 29.7 MHz
- Input Impedance: 50 Ω unbalanced
- Output Impedance: 20~150 Ω unbalanced
- Insertion Loss: Less than 0.8 dB
- Through Power: 150 W
- Maximum Tuning Time: Less than 15 seconds.

LF-30A

Low-Pass Filter

SPECIFICATIONS

- Cutoff frequency: 30 MHz
- Attenuation: More than 90 dB between 90 and 300 MHz
- Durability against input power: 1 kW PEP
- Insertion loss: Less than 0.5 dB at 30 MHz
- Input/output impedance: 50 Ω
- Dimensions: 244 (9.6) W \times 50 (1.97) H \times 40 (1.57) D mm (inch)
- Weight: Less than 560 g (1.2 lbs.)



FEATURES

OUTSTANDING RECEIVER PERFORMANCE AND SENSITIVITY SPECIFICATIONS

Superior Dynamic Range Receiver Front End.

The TS-940S RF circuits have been specifically designed to provide the lowest noise floor level coupled with a superior dynamic range. Use of 2SK125 junction-type FET's wired in a cascode amplifier circuit, followed by two 2SK125's each in the first balanced mixer and in the push-pull gate grounded buffer amplifier, and working into a 2nd balanced mixer circuit, results in outstanding two-signal characteristics accompanied by a substantially improved noise floor level. The IM (intermodulation) dynamic range characteristic for the TS-940S receiver section is typically 102 dB (20 meters, 50 kHz spacing, 500 Hz CW bandwidth), with an overall intercept point of +14 dBm, noise floor level of -138 dBm and the blocking dynamic range at a point 200 kHz to either side of the center frequency of the IF filter is -139 dB (typical).

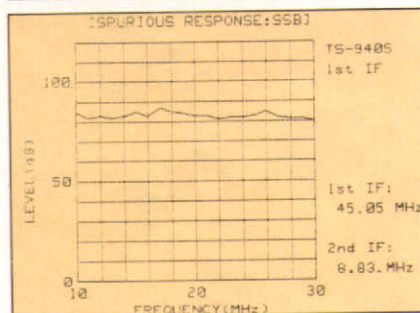
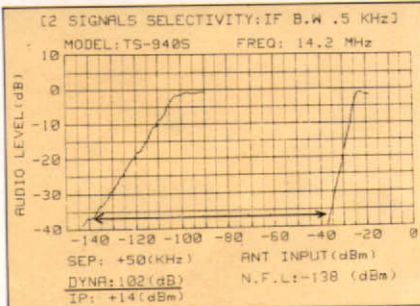

160-m to 10-m Amateur Band Operation with 150 kHz to 30 MHz General Coverage Receiver.

The TS-940S covers all Amateur bands from 160 to 10 meters, including the new WARC 30, 17, and 12 meter bands. Its general coverage receiver provides reception on any frequency from 150 kHz to 30 MHz. An innovative quadruple conversion, digital PLL synthesized circuit provides a 1st IF at 45.05 MHz, a 2nd IF at 8.83 MHz, a 3rd IF at 455 kHz, and a 4th IF at 100 kHz. The KENWOOD

conceived and engineered digital PLL circuit provides superior frequency accuracy and stability since only the standard frequency crystal oscillator determines those parameters. Selection of a specific Amateur band may be speedily and efficiently accomplished by the touch of the appropriate band access key (10 keys provided), or through use of the UP/DOWN 1 MHz step band switches, allowing easy access to all frequencies in the 150 kHz to 30 MHz range. Each of the two digital VFO's is continuously tunable from band to band across the full range of the transceiver.

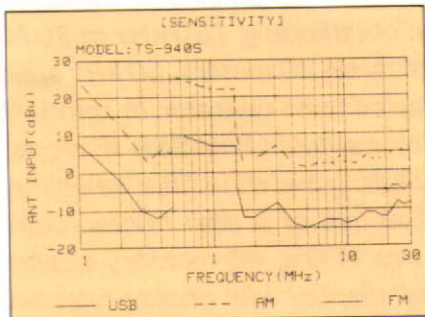

All-Mode Operation.

Modes of operation include USB, LSB, CW, AM, FM, and FSK. Mode selection is quickly effected through use of the proper front panel mode key. An adjacent LED confirms the selection. When a key is depressed, the first letter of the mode selected is announced in Morse code through the internal speaker, e.g., "L" for LSB, "F" for FM, etc. When FSK is selected, the Morse code letter "R" (for RTTY) is heard.

Superb Interference Reduction.

The TS-940S incorporates a number of special interference control circuits perfected by KENWOOD and described in the following, that give the operator maximum capability to minimize the effect of interference of all kinds.

(1.) SSB IF Slope Tuning.

This feature operates in the LSB and USB modes. Front panel controls are provided to allow independent adjustment of either the low frequency or high frequency slopes of the IF passband. These HIGH CUT and LOW CUT controls permit the operator to easily and quickly define the most ideal IF passband width consistent with readability and interference rejection, and based on conditions as they exist at the time of the contact. The settings of the controls may be graphically illustrated on the LCD sub-display panel.

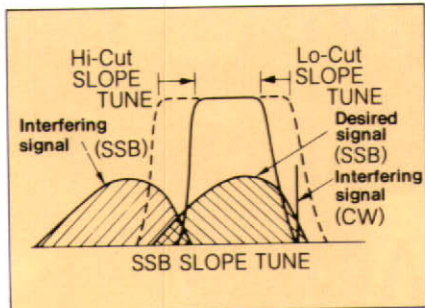

(2.) CW VBT (Variable Bandwidth Tuning.)

When all optional filters are installed, CW VBT operates in the CW, FSK and AM modes. When none of the optional filters are installed, CW VBT operates in the CW and FSK modes with the filter switch positioned at WIDE, and in the AM mode with the filter switch positioned at NARROW. In the CW mode of operation, the CW VBT and pitch control circuits are automatically enabled. The VBT control allows the passband width to be continuously varied within the range of the control without affecting the center frequency. Graphic illustration of these adjustments is accomplished on the LCD sub-display panel.

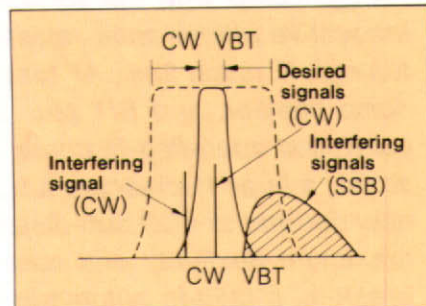

(3.) IF Notch Filter.

A tunable notch filter is located between the 4th receive mixer and the 100 kHz IF amplifier. The use of L-C-R components in a bridged-T filter circuit at the 100 kHz IF frequency results in deep, sharp notch characteristics that provide attenuation on the order of 40 dB to the interfering signal. As shown in the figure below, only the interfering signal is reduced while the desired signal remains unaffected. The resonant frequency of the filter is shifted by varying the voltage applied to the cathode of the vari-cap diode. The filter operates in all modes (except FM mode).

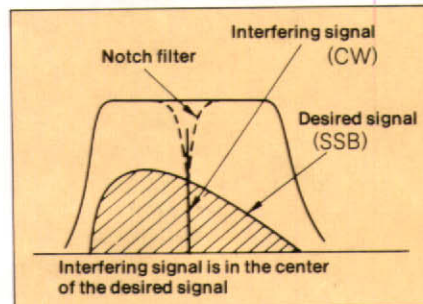

(4.) Audio Filter Built-in.

The next chart shows the principle of the AF-Tune feature, which reduces interfering signals and white noise, providing a peak tuning characteristic for the AF frequency response. When the front panel "AF-Tune" switch is depressed to the "ON" position, the "AF-Tune" circuit is activated, allowing operation only in the CW mode. The circuit consists of a three pole active filter located between the SSB/CW demodulator and the AF amplifier. It is tunable to a center frequency of 800 Hz, variable ± 400 Hz or greater.

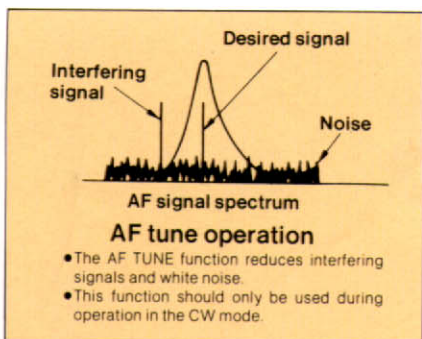

(5.) Narrow/Wide Filter Selection.

A front panel "NAR/WIDE" switch allows narrow/wide IF filter selection as required, based on interference conditions. The use of an 8.83 MHz 2nd IF, followed by a 455 kHz 3rd IF promotes excellent selectivity, with maximum potential for the use of various filter combinations to further enhance that important performance characteristic. The TS-940S comes with 2.7 kHz SSB filters (both 8.83 MHz and 455 kHz IF), and a 6 kHz AM filter (455 kHz IF), built-in. A selection of easily installed plug-in optional filters is available for the operator who requires maximum selectivity control.

W/N switch	WIDE		NARROW	
Mode	2nd IF filter	3rd IF filter	2nd IF filter	3rd IF filter
SSB	2.7 kHz*0	2.7 kHz*0	2.7 kHz*0	2.7 kHz*0
CW,FSK	2.7 kHz	2.7 kHz	0.5 kHz*2 or 0.25 kHz*4	0.5 kHz*3
AM	6 kHz*1	6 kHz	2.7 kHz	2.7 kHz
FM	Wide band	12 kHz	Wide band	12 kHz

*0 2.7 kHz+2.7 kHz=2.4 kHz (Total selectivity)
 *1 option YK-88A-1 installed
 *2 option YK-88C-1 installed
 *3 option YK-455C-1 installed
 *4 option YK-455CN-1 installed

Built-in CW Variable Pitch Circuit.

The CW pitch control shifts the 4th IF passband in the demodulator circuit while, at the same time, raising or lowering the pitch of the audible beat frequency. This is very useful in avoiding interference or for changing the pitch tone to a frequency that is easier to copy.

Dual-Mode Noise Blanker ("Pulse" or "Woodpecker".)

The noise blanker consists of two circuits, NB-1 and NB-2, each actuated by its own front panel switch. Noise sampled from the receive 2nd mixer output transformer is amplified approximately 70 dB by a noise amplifier. The NB level control adjusts the threshold level of the noise amplifier, allowing the operator to control the effectiveness of the noise blanker under the specific noise and signal level conditions. Depressing the NB1 switch is most effective in suppressing pulse-type (ignition) noise. Depressing the NB2 switch is most effective in suppressing noise of a longer duty cycle nature, such as the so-called "woodpecker" type of interference. The threshold level in the NB2 position is factory optimized for maximum effectiveness with minimum degradation of the desired signal.

Built-in RIT/XIT.

The front panel "RIT" (Receiver Incremental Tuning)/"XIT" (Transmitter Incremental Tuning) control shifts the receive or transmit frequency in 10 Hz steps across a range of ± 9.99 kHz, using an optical encoder, to tune stations that are slightly off frequency, and without affecting the VFO transmit/receive frequency. RIT/XIT frequency shifts (0.0~ ± 9.99 kHz) are displayed in the main display area. A "CLEAR" switch resets the RIT/XIT frequency to zero. The "RIT/XIT" control may be used in any mode of operation.

All-Mode Squelch Circuit.

The squelch circuit is effective in suppressing background noise in all operating modes.

RF Attenuator.

The meticulously engineered receiver section front end includes a 4-step, 0, 10, 20, or 30 dB RF attenuator, for optimum rejection of intermodulation distortion.

Switchable AGC Circuit (OFF/FAST/SLOW).

The automatic gain control (AGC) is activated by a 3-position (OFF/FAST/SLOW) switch, to provide optimum receiver operation in all modes, and under all signal strength conditions.

AUTOMATIC ANTENNA TUNER PLUS LOW DISTORTION, HIGH RELIABILITY TRANSMISSION

Automatic Antenna Tuner (160-10 meters) Built-in.

The TS-940S is available with a completely automatic antenna tuner covering all Amateur bands from 160 through 10 meters built-in, or may be ordered without the tuner installed. An AT-940 antenna tuner is available for future installation in transceivers initially ordered without the automatic antenna tuner. With the "AUTO/THRU" switch in the "AUTO" position, depressing the "AT.T" key sets up the automatic tune condition, which lasts for approximately 3 seconds. The LCD sub-display reads "ANTENNA TUNER AUTO-TUNE READY." Keying the transmitter while this message is being displayed initiates automatic tuning at the 50 watt RF output level, using high speed motors to reduce the tuning time. During the tuning cycle, the LCD sub-display indicates "ANTENNA TUNER TUNING...!!" When the SWR drops to its minimum value, a "motor-stop" signal is generated, instantaneously stopping the motors and the tuning action, and the LCD sub-display indicates "TUNING FINISHED TX-READY."

Low Distortion, High Reliability 28 Volt Powered Final Amplifier.

Through the use of a 28 volt power source, the quality of the transmitted signal has been measurably improved (3rd order intermodulation distortion better than -37 dB) compared to other contemporary designs. Two MOTOROLA MRF-422 (Pd 290 watts each), operating push-pull, are used in the final amplifier. Temperature and VSWR monitoring circuits are incorporated in the final amplifier protection circuit to guard against failure of these important components. Continuous operation in the CW or RTTY modes of operation is possible, due to the oversize heat-sink design coupled with new, super-quiet, ducted cooling system.

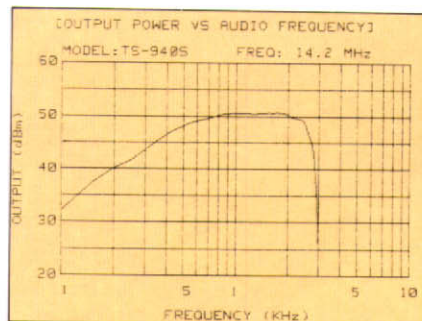
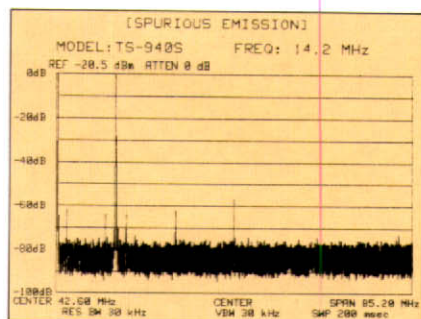
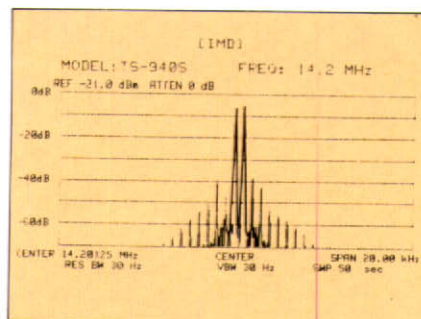
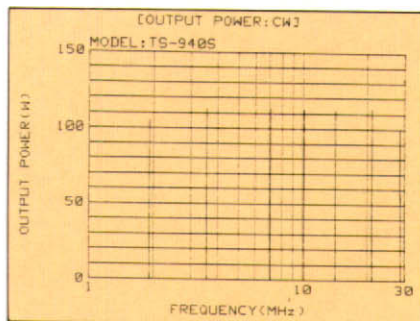

CW Full Break-in

A full break-in capability allows the DX or contest operator to respond more quickly to the calling station. To the "ragchewer", it means a more natural conversation. This capability is made possible through use of CMOS IC's in the timing logic circuitry. The actual switching is accomplished using a specially constructed, fast-acting reed relay, which also serves to eliminate the distracting sounds typical of a conventional relay. A front panel switch permits switching to semi break-in operation.

Built-in Speech Processor.

The TS-940S employs speech processing circuitry based on RF clipping techniques. A marked improvement in the intelligibility threshold is attainable, depending on the positions of separate front panel "IN" and "OUT" controls. A higher average "talkpower" plus improved intelligibility makes for outstanding DX performance.

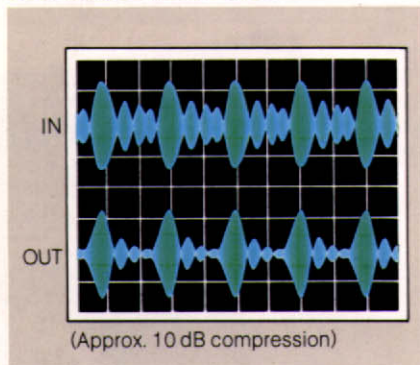

RF Output Power Control.

Using a front panel control, the RF output power may be continuously varied from 10 watts to the maximum power, in any mode of operation.

OPERATING FREQUENCY CONTROL USING NEW MICROPROCESSOR PLUS DIGITAL TECHNOLOGY.

The use of a new microprocessor plus advanced digital technology to control the various tuning functions, including the 2 digital VFO's, the 40 channels of memory, band scan and memory scan, etc., assures maximum flexibility and ease of operation under the most difficult operating conditions.

10 Hz Step Dual Digital VFO's with Optical Encoder.

Special tuning logic, working in conjunction with the basic 10 Hz step, high stability digital VFO design, provides a variable speed tuning characteristic that is directly related to the speed of tuning knob rotation. A large, die-cast tuning knob with molded rubber cover, rotated at normal tuning speeds, results in a frequency shift in 10 Hz increments, or 10 kHz per tuning knob revolution. Rotation of the tuning control at speeds in excess of approximately 2 to 3 revolutions per second causes the tuning step size to be increased proportionally, speeding up the rate of frequency change. Each VFO tunes continuously across the full coverage of the transceiver, utilizing the KENWOOD engineered special optical encoder tuning system.

Built-in Dual VFO A/B Switching System.

An "A/B" switch allows the operator to specify the VFO to be used. A "SPLIT" switch is available for split frequency operations. An "A=B" switch makes it possible to quickly duplicate the tuning data (frequency, mode, RIT data) programmed into the active VFO, in the data banks of the inactive VFO. A "T-F SET" switch is provided to permit reversal of the transmit and receive frequencies during split frequency operations. All of these switches are front panel mounted.

40 Memory Channels.

For operating purposes, the 40 memory channels are divided into 4 groups of 10 channels each. Both mode and frequency data are stored, making all operations simple and convenient. The operator may select any 1 of the 4 memory groups for operations, using the 4 position memory bank switch located on the top panel. Depressing the "VFO/M" switch on the front panel permits selection of the memory channel, using the 10 band keys. The "M VFO" switch is used to transfer memory data (frequency and mode) to the active VFO. Memory information is backed-up by an internal lithium battery. (Est. 5 yr. life.)

Built-in Scan Functions.

Memory scan is initiated by depressing the "MS" switch. Memories in which no data is stored are skipped. Programmable band scan is initiated by depressing the "PG.S" switch, and scans in 10 Hz (100 Hz in AM, FM modes) steps from the lowest frequency within the frequency limits specified in memory channels "9" and "0". A "HOLD" switch is provided to interrupt the scanning process during memory and program scan operations. When the "HOLD" switch has been depressed during program scan, the VFO operating frequency may be adjusted within the frequency limits established in memory channels "9" and "0".

Rapid Band Selection.

A specific Amateur band may be quickly selected by depressing the appropriate front panel band key. One MHz step "UP" and "DOWN" switches on the front panel allow rapid selection of shortwave broadcast frequencies. An "F.LOCK" switch prevents accidental loss of the selected frequency.

Keyboard Frequency Selection

The VFO frequency may be directly entered using the front panel number keys. Simply press the "ENT" key, followed by the desired frequency.

MULTI-FUNCTION MAIN DISPLAY AND SUB-DISPLAY.

The TS-940S incorporates a large fluorescent tube digital display with a unique analog-type sub-scale, plus a new dot-matrix LCD sub-display that displays alpha-numeric information and graphic characteristics.

Large Fluorescent Tube Digital Main Display.

The large, built-in, multi-function fluorescent tube display and its analog-type sub-scale provides improved readability and allows increased operating speed. Transmit/receive frequencies appear on a 7 numeral digital display/analog sub-scale combination, indicating tuning across a selected 1 MHz/100 kHz band segment in 20 kHz/2 kHz steps. A red indicator on the analog scale keeps pace with the tuning knob rotation. A separate 2-digit display indicates RIT/XIT frequency shift to ± 9.99 kHz. There are also indicators for VFO "A" or "B", memory "ON", memory channel number, "F.LOCK", and RIT/XIT "ON". The use of the fluorescent tube display makes reading easy, and minimizes eye fatigue. A "DIM" switch has been provided to allow dimming of the display and the meter illumination, if desired.

LCD Dot-matrix Sub-display.

The sub-display is capable of displaying a maximum of 16 digits and 2 lines of data. Frequency, graphic characteristics, messages, and clock time are the 4 different kinds of information that can be displayed.

■ Frequency.

The upper line shows frequency and mode of VFO "B" when VFO "A" is indicated on the main display. The lower line indicates memory group (1-4), memory channel (CH-1, 2, ..., 0), plus frequency and mode during VFO operations.

■ Graphic Characteristics.

Graphically indicates the effect on bandwidth when "SSB SLOPE TUNE" or "CW VBT" controls are operated.



■ Messages.

Displays messages relating to operation of the Automatic Antenna Tuner, as follows:

1. "ANTENNA TUNER AUTO TUNE READY" when "AT.T" switch is depressed.
2. "ANTENNA TUNER TUNING" when transmitter is keyed within 3 seconds after pressing "AT.T" switch.
3. "TUNING FINISHED TX-READY" when automatic antenna tuner has finished tuning.

■ Clock.

Indicates the current time, or the preset timer time. The clock has a built-in battery back up. (Est. 3yr. life)

MECHANICAL DESIGN AND CONSTRUCTION TYPICAL OF COMPETITION-CLASS EQUIPMENT.

The clean, sharp, lines and functional stability so characteristic of die-cast construction are quickly recognized in the beautiful front panel and in the highly efficient heat sink design found on the rear of the unit.

Temperature control of critical components is accomplished with peak efficiency through use of a new air distribution system that allows operation on a 100% transmit duty cycle basis for periods of approximately one hour.

The high-density design concept enables the complete power supply circuitry and the automatic antenna tuner, as well as the balance of the transceiver electronics to be built into a compact cabinet normally sized for the transceiver electronics alone.

Rugged Zinc Die-cast Front Panel and VFO Control Knob.

The Zinc die-cast front panel assures maximum mechanical stability under even the most severe operating conditions. A large die-cast VFO control knob, with a textured rubber cover, provides a positive tuning "feel" coupled with a strong flywheel effect, further enhancing the unit's flexibility of use and ease of operation.

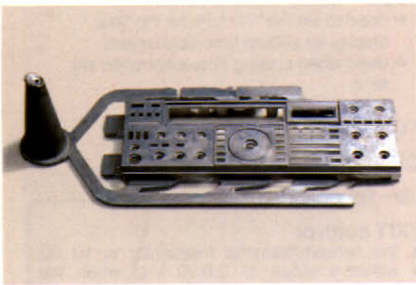

Efficient Cooling System Allows 100% Transmit Duty Cycle.

The 100 W final amplifier stage is mounted directly on its die-cast aluminum heat sink and by using a ducted air-flow cooling system, provides maximum thermal conduction efficiency. The high efficiency of the cooling system permits continuous transmission at full power for periods of approximately one hour without thermal shut-down.

The power supply unit has its own independent cooling system and fan, also incorporating the ducted air-flow concept.

A VARIETY OF EXTRA, EASY-TO-OPERATE FUNCTIONS.

Built-in AC Power Supply and Speaker.

The TS-940S is a self-contained HF station, including a built-in power supply, and a rugged, top-mounted, high quality, 10 cm (4 inch) speaker. The power supply circuit provides ample capacity through the use of a special, compact, laminated core transformer, assuring maximum stability of operation of the final transistor circuits. The correct AC circuit polarity is achieved through use of the 3-wire connector and cable assembly supplied with the unit.

Clock/Timer Function.

In addition to a 24-hour clock function, a single event timer is provided for scheduled un-attended recording of a specified transmission. Clock/Timer program data may be displayed on the LCD sub-display at the operator's option.

Transmission Monitor Circuit.

A built-in transmit monitor circuit operating in the SSB, FM, and FSK modes may be operator activated by depressing the front panel "MONI" switch. This circuit monitors the product detector signal from the output of the IF section during transmission, allowing the operator to check his audio quality, and the effectiveness of the speech processor.

High Stability RTTY Transmit Circuit.

The stability of RTTY transmissions is greatly improved through design that obtains the FSK signal information from the reference oscillator. The FSK shift width is 170 Hz.

Voice Synthesizer Unit (Optional).

An optional VS-1 "Voice Synthesizer Unit", which announces the operating frequency on demand by depression of the front panel "VOICE" key, is available. Installation within the cabinet is simple and easy.

Optional SO-1 TCXO "Temperature Compensated Crystal Oscillator".

An optional, high-stability TCXO, model SO-1, may be installed in place of the reference oscillator. The SO-1 oscillator operates at a frequency of 20 MHz and has a thermal stability of $\pm 5 \times 10^{-7}$.

ADDITIONAL FEATURES, PLUS ACCESSORY TERMINALS.

Dimmer Switch

A front panel "DIM" switch permits selection of either normal or reduced intensity on the digital display and SWR/POWER meter.

100 kHz Marker.

A 100 kHz marker signal, controlled by a switch located under the sliding panel on top of the unit, is available for use in calibrating the fundamental oscillator against received standards such as WWV or JJJ.

VOX Circuit.

The VOX gain, VOX delay, and Anti-VOX controls are located beneath the sliding panel on the top of the cabinet.

Meter Functions.

"COMP" (Compression), "ALC" (Automatic Level Control), "POWER" (RF Output Power), "SWR" (Standing-wave Ratio), "IC" (Final Amplifier Collector Current), and "VC" (Final Amplifier Collector Voltage.) S units and dB on receive.

LED Indicators for Miscellaneous Functions.

"ON AIR", "AT", "TUNE", "SPLIT", "NOTCH", "NAR".

Input/Output Terminals

RX antenna terminal and switch, transverter terminal, IF OUT 1 (For PAN-DISPLAY) and IF OUT 2 (Oscilloscope Modulation Monitor) terminals, phone patch IN/OUT terminals, accessory terminals 1 and 2, remote control terminal.

TS-940S BLOCK DIAGRAM

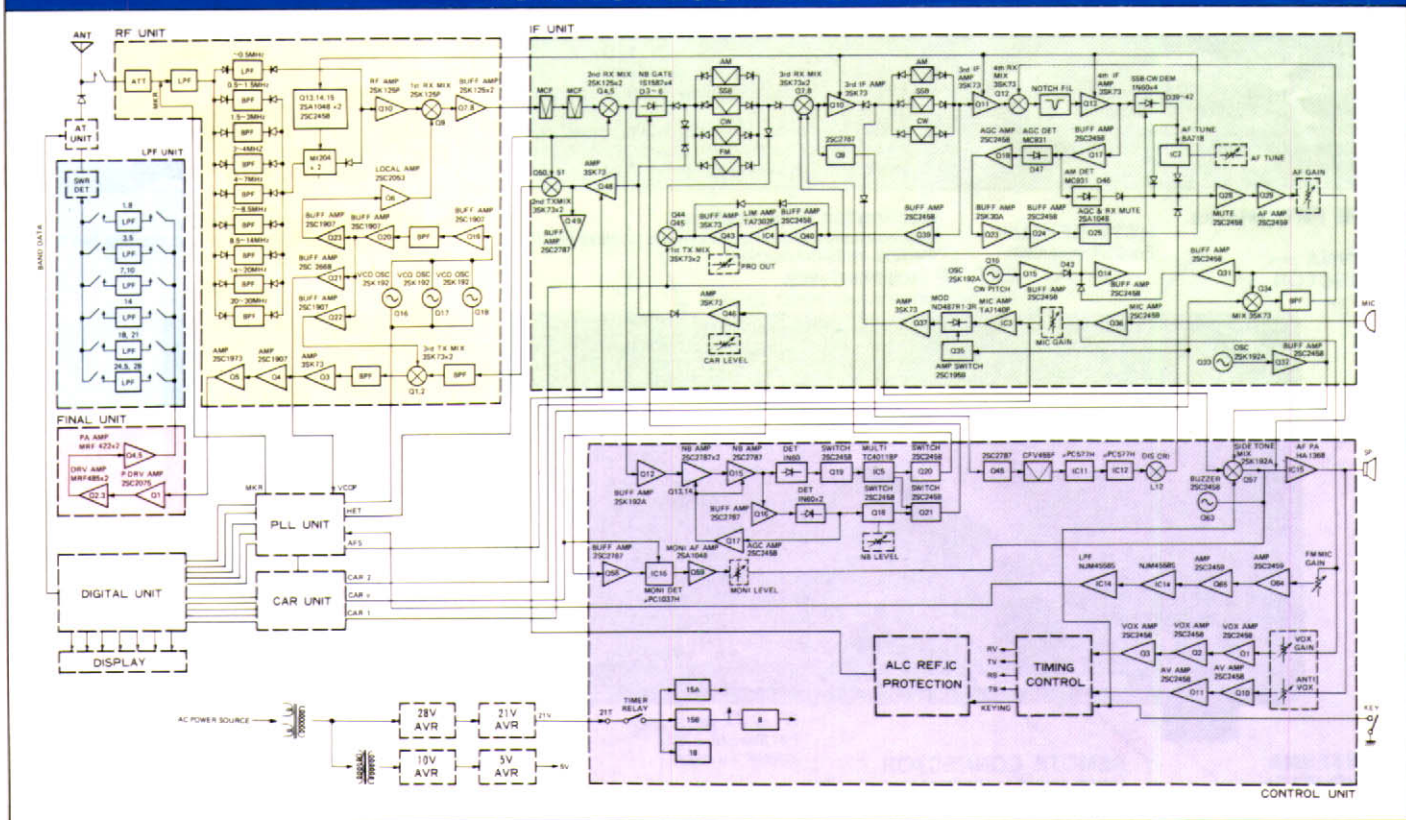

TS-940S SPECIFICATIONS

[GENERAL]

Transmitter

Frequency Range . 160-m band 1.8~2.0 MHz
 80-m band 3.5~4.0 MHz
 40-m band 7.0~7.3 MHz
 30-m band 10.1~10.15 MHz
 20-m band 14.0~14.35 MHz
 17-m band 18.068~18.168 MHz
 15-m band 21.0~21.45 MHz
 12-m band 24.89~24.99 MHz
 10-m band 28.0~29.7 MHz

Receiver Frequency Range 150 kHz~30 MHz
Mode A3J [J3E] (USB, LSB), A1 [A1A] (CW)
 F1 [F1B] (FSK), F3 [F3E] (FM), A3 [A3E] (AM)
Frequency Stability ... $\pm 10 \times 10^{-6}$ ($-10^{\circ}\text{C} \sim +50^{\circ}\text{C}$)
Frequency Accuracy .. $\pm 10 \times 10^{-6}$ (at normal temperatures)
Antenna Impedance ... 50 Ω (20~150 Ω with the AT-940 antenna tuner installed, transmission only)
Power Requirements .. 120/220/240 VAC, 50/60 Hz
Power Consumption .. Max. transmit 510 W
 Receive (no signal) 80 W
Dimensions 401(15.79) W x 141(5.55) H x 350(13.78) D mm (inch) (Projections not included)
Weight 18.5 kg (40.78 lbs.) approx.
 20 kg (44.09 lbs.) approx. (with antenna tuner)

[Transmitter]

Final Power Input SSB/CW/FSK/FM=250 W PEP
 AM=140 W
Modulation SSB=Balanced Modulation
 FM=Reactance Modulation
 AM=Low Level Modulation

FM Maximum Frequency Deviation ± 5 kHz
FSK Shift Width 170 Hz
Carrier Suppression .. Less than -40 dB
Spurious Response ... Less than -40 dB (CW)
Unwanted Sideband Suppression Better than 50 dB
 (Modulation frequency: 1.5 kHz)

Third Harmonic Intermodulation Distortion Better than -37 dB (at 14.2 MHz)
 (based on single tone output)

Microphone Impedance 500 Ω ~50 k Ω
Frequency Response (SSB) 400~2600 Hz (-6 dB)

[Receiver]

Circuitry SSB/CW/AM/FSK: Quadruple conversion system
 FM: Triple conversion system

Intermediate frequency 1st IF 45.05 MHz
 2nd IF 8.83 MHz
 3rd IF 455 kHz
 4th IF 100 kHz

Sensitivity at 10 dB (S/N) (0 dB μ =1 μ V)

Frequency Mode	150~500 kHz	500 kHz~1.8 MHz	1.8~30 MHz
SSB, CW, FSK	Less than 1 μ V	Less than 4 μ V	Less than 0.2 μ V
AM	Less than 10 μ V	Less than 32 μ V	Less than 2 μ V
FM (SINAD 12 dB)	-	-	Less than 0.5 μ V

Squelch Sensitivity ... Less than -10 dB μ (0.32 μ V)
Image Ratio More than 80 dB (1.8~30 MHz)
IF Rejection More than 70 dB (1.8~30 MHz)
Selectivity SSB, CW, AM (N), FSK
 2.4 kHz (-6 dB)
 3.6 kHz (-60 dB)
 AM (W)
 6 kHz (-6 dB)
 15 kHz (-50 dB)
 FM
 12 kHz (-6 dB)
 22 kHz (-60 dB)

Variable Frequency Range SSB slope tuning (with SSB filter)
 High-cut=more than 1500 Hz
 Low-cut=more than 700 Hz
 CW VBT (without optional filter)
 600 Hz~2.4 kHz (continuous)

RIT/XIT Variable Range ± 9.99 kHz
Notch Filter Attenuation More than 40 dB
Audio Output Power ... 1.5 W (8 Ω at 10% distortion)

The equipment meets or exceeds published specifications. Specifications are subject to change without notice due to advances in technology.



TRIO-KENWOOD CORPORATION

Shionogi Shibuya Building, 17-5, 2-chome Shibuya, Shibuya-ku, Tokyo 150, Japan

TRIO-KENWOOD COMMUNICATIONS

1111 West Walnut Street, Compton, California 90220, U.S.A.

TRIO-KENWOOD COMMUNICATIONS

DIVISION OF TRIO-KENWOOD ELECTRONICS GmbH

Rembrücker Str. 15, 6056 Heusenstamm, West Germany

TRIO-KENWOOD ELECTRONICS, N.V.

Leuvensesteenweg 504, B-1930 Zaventem Belgium

TRIO-KENWOOD (AUSTRALIA) PTY. LTD. (INCORPORATED IN N.S.W.)

4E, Woodcock Place, Lane Cove, N.S.W. 2066, Australia